



Manual

e-MatriX 800-RD/ST (LL) ENG



Registration plate:

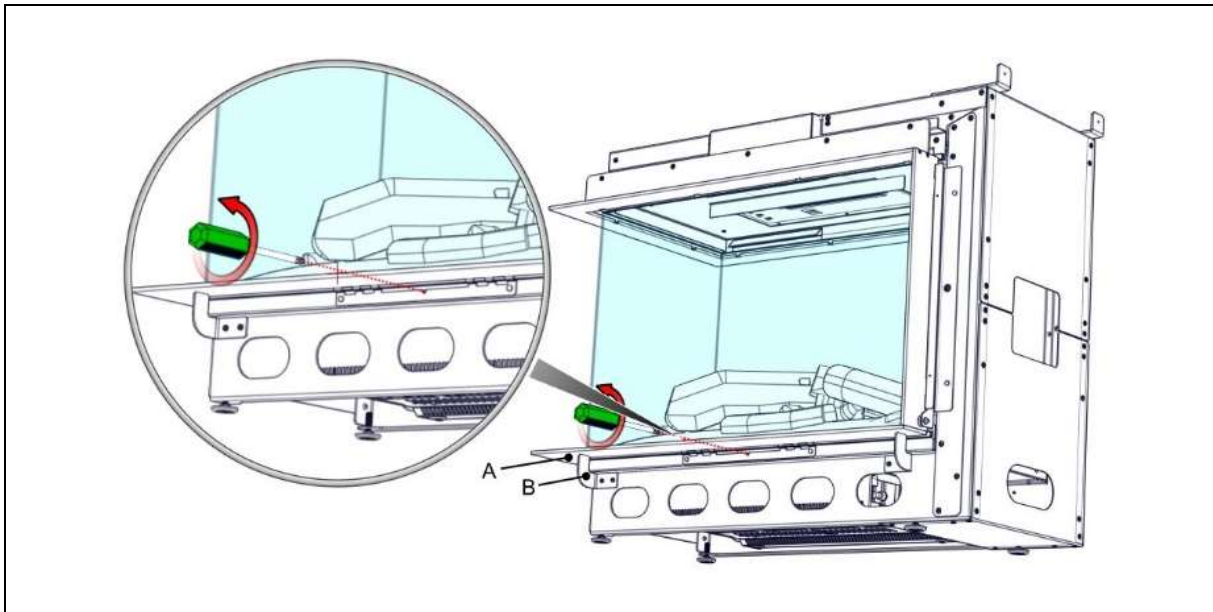

1.0

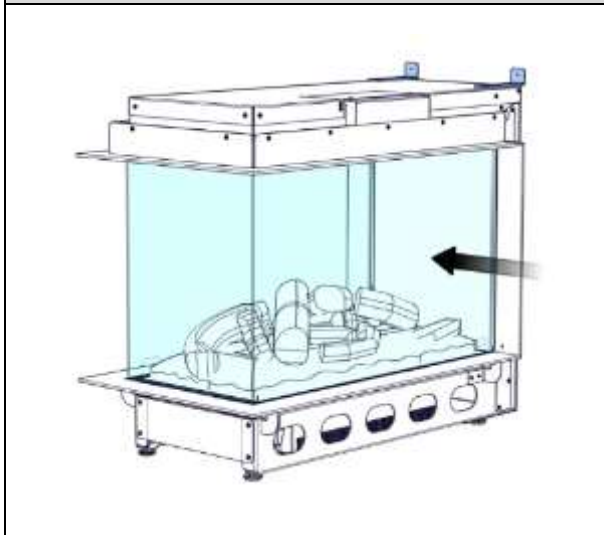

1.1a

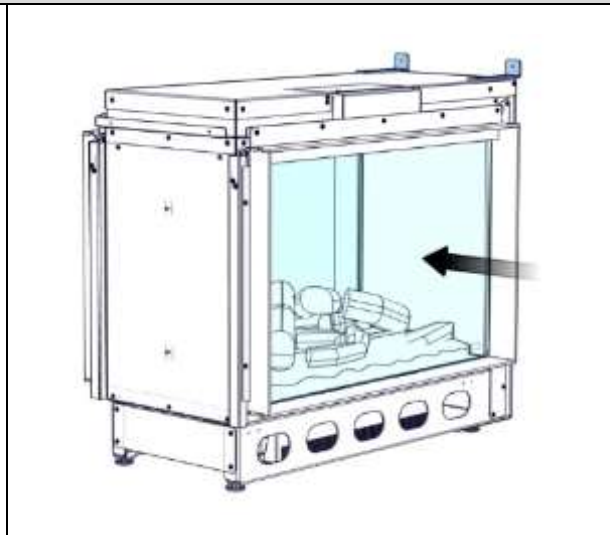

1.1b



1.2

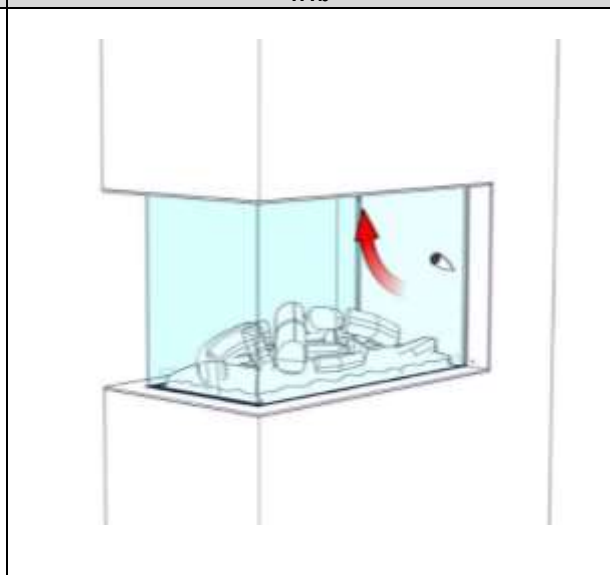

2.0a

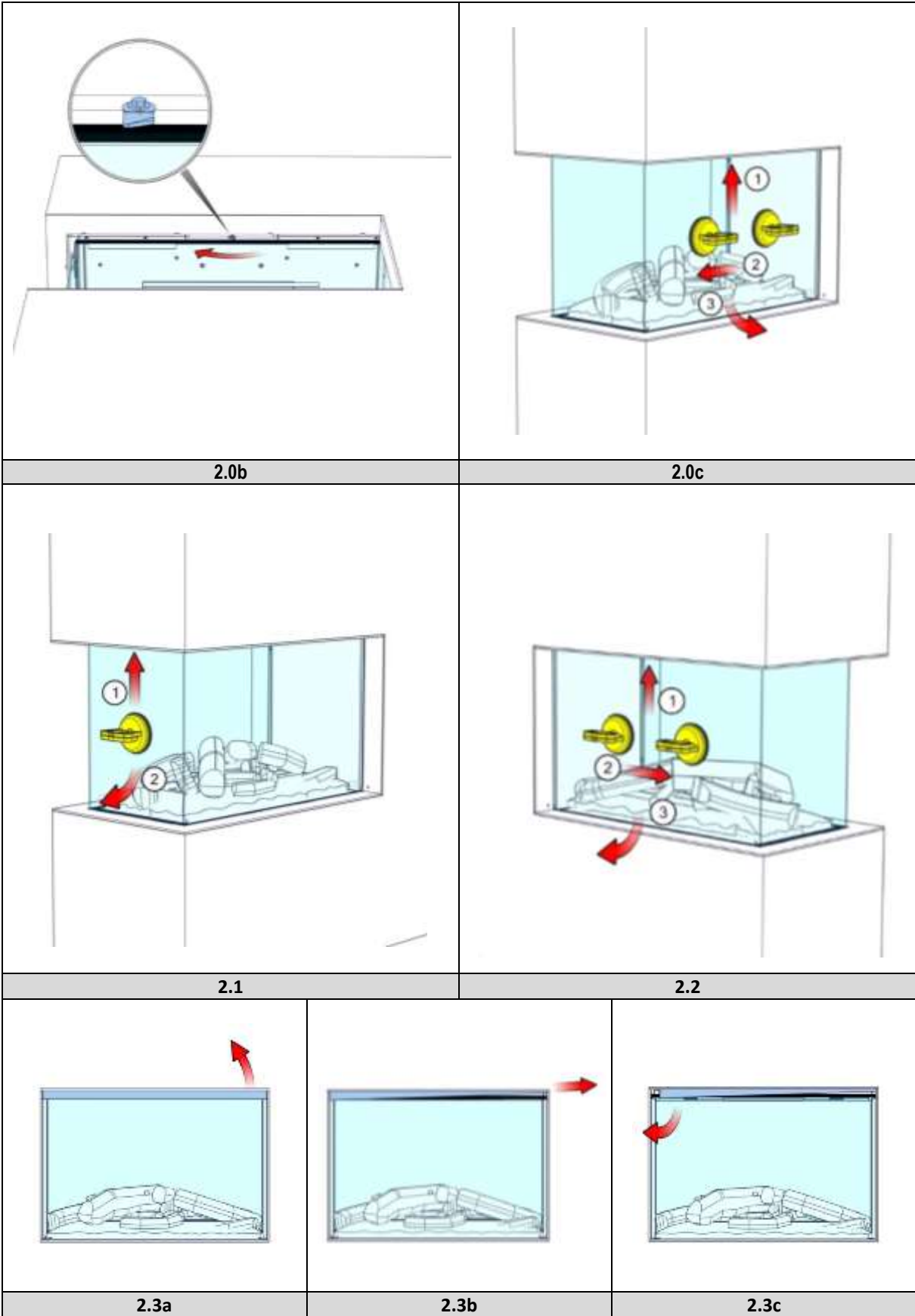

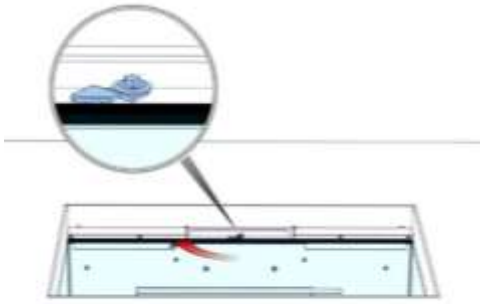
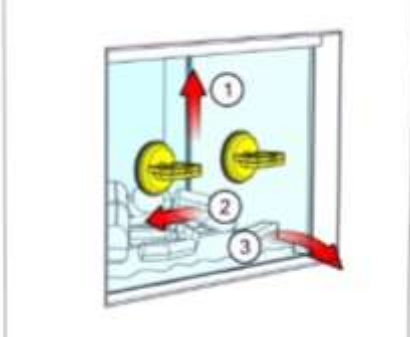
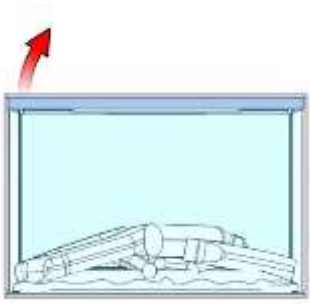
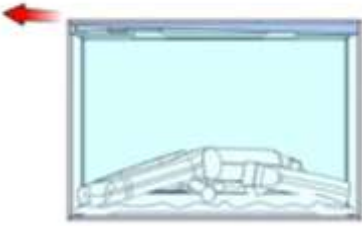
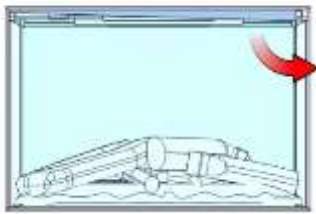
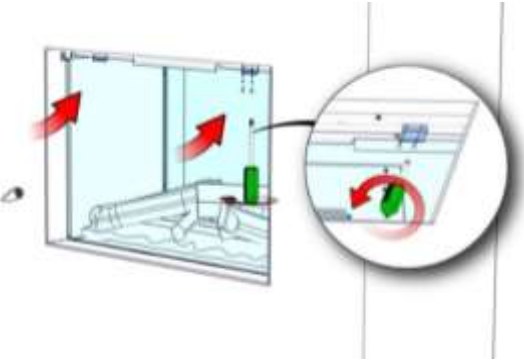
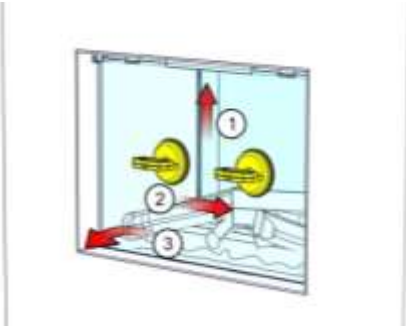
		
<p>2.3d</p>	<p>2.3e</p>	
		
<p>2.3f</p>		
		
<p>2.4a</p>	<p>2.4b</p>	<p>2.4c</p>
		
<p>2.4d</p>	<p>2.4e</p>	

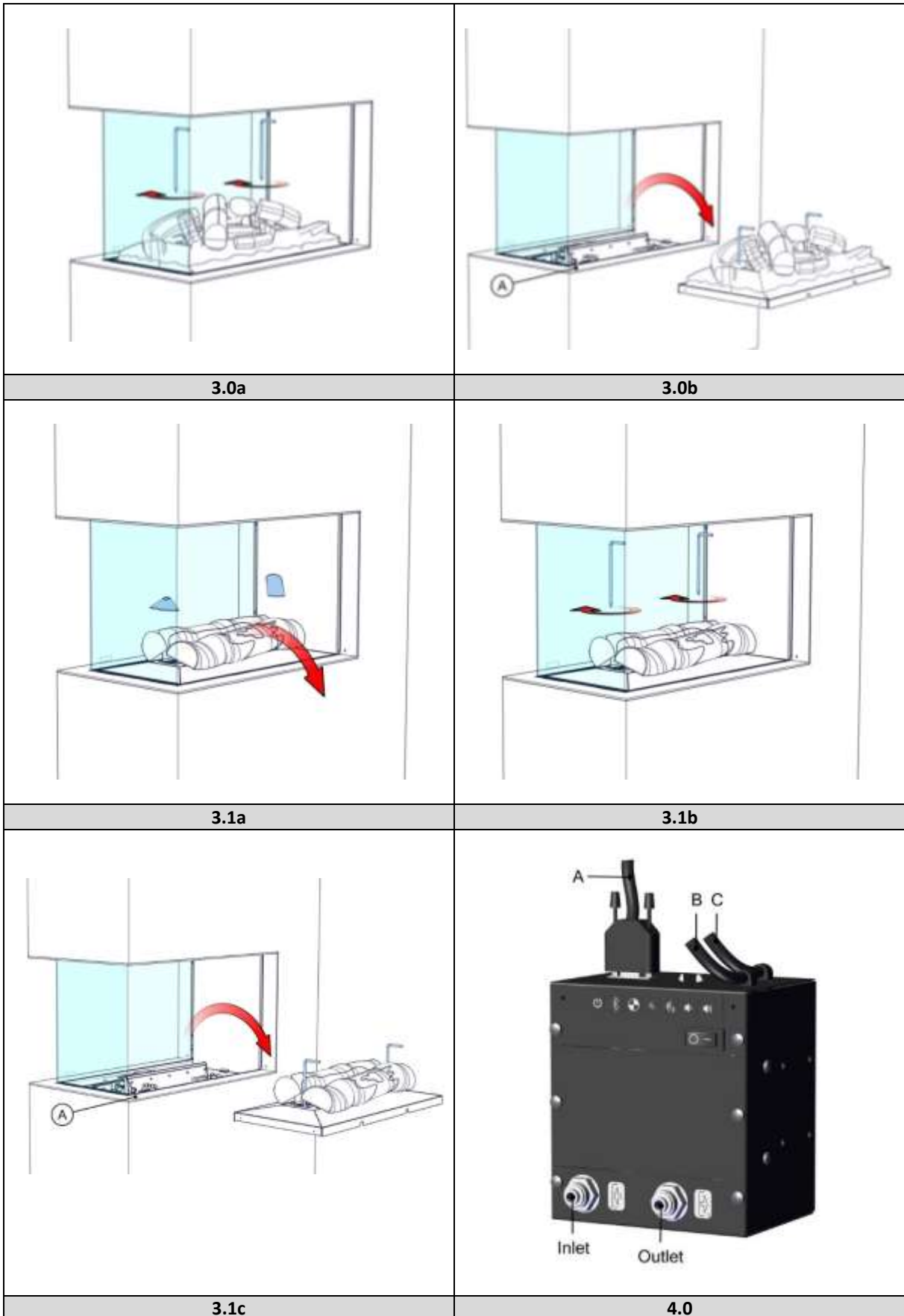

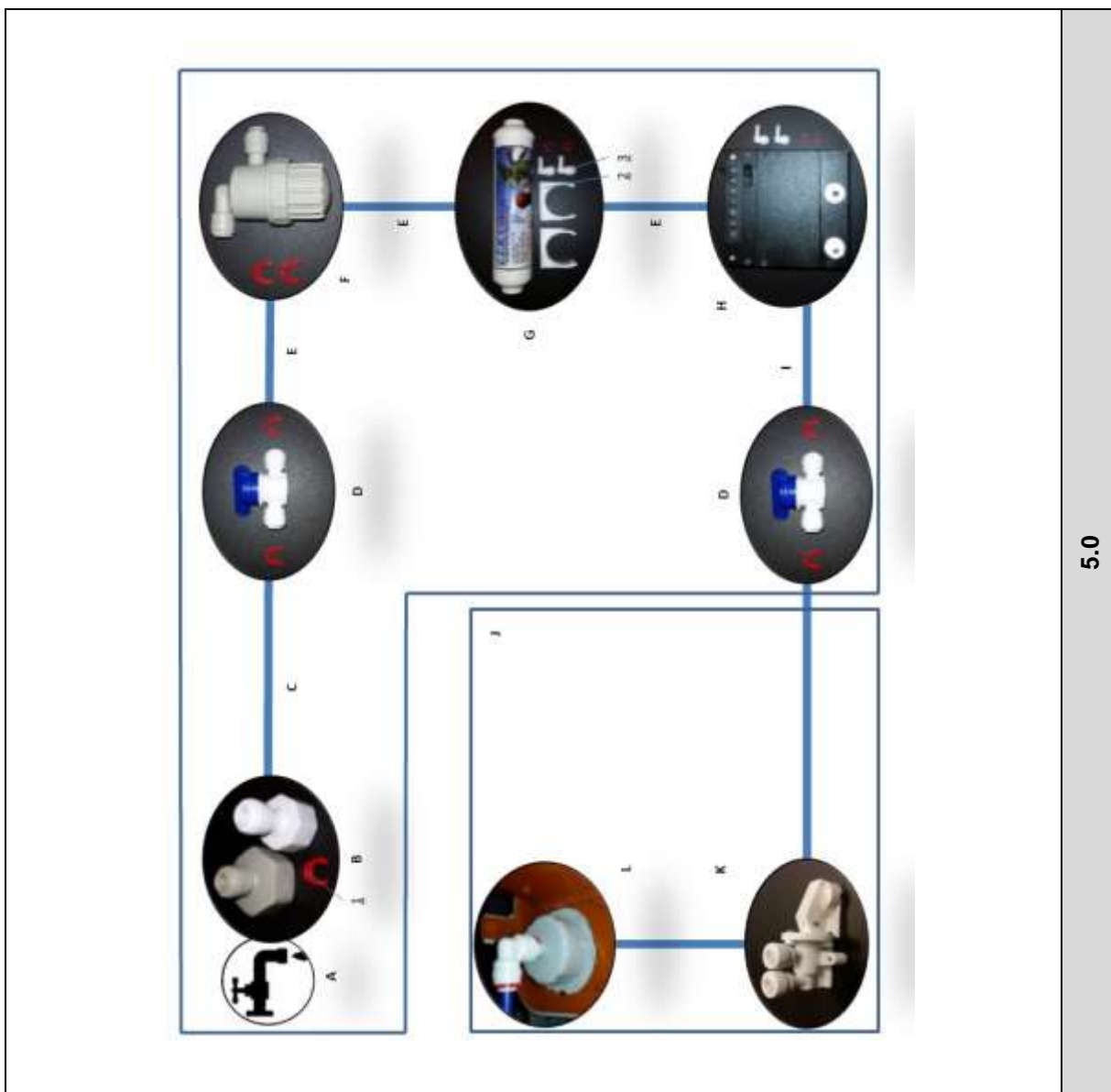
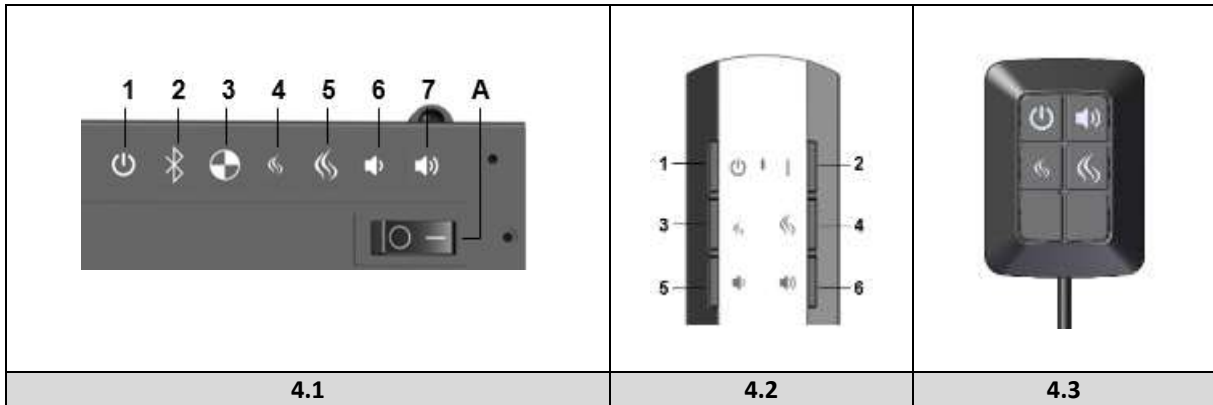

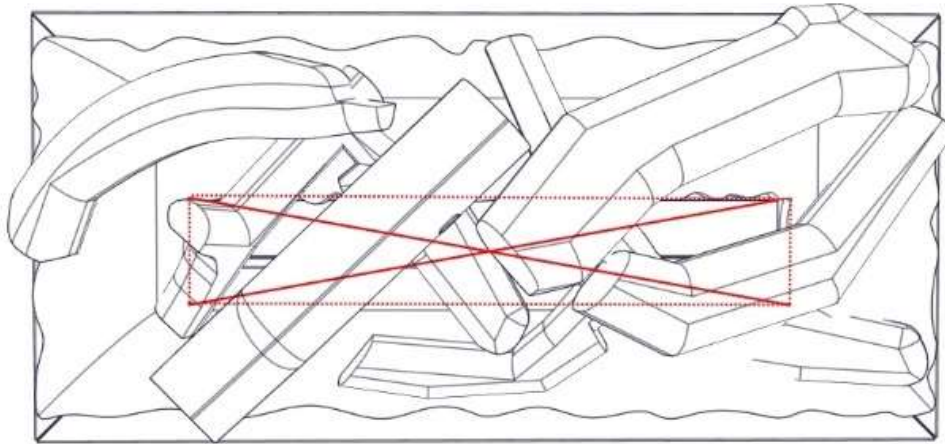

6.0

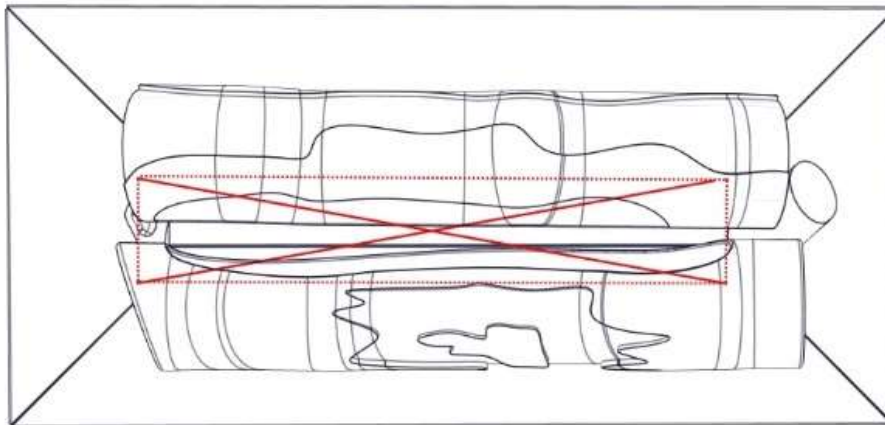

6.1

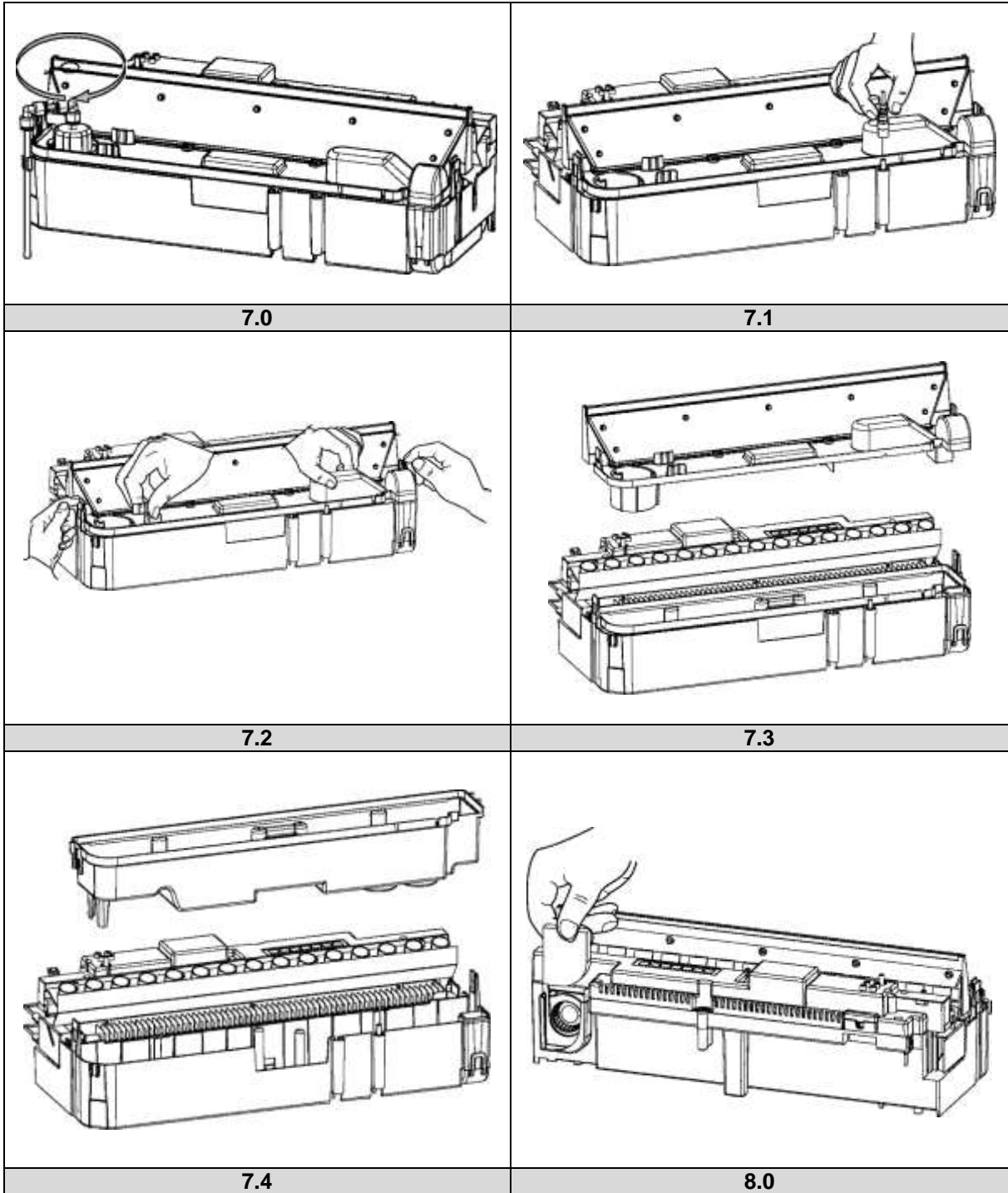

1 General

1.1 Introduction

Only have the fire installed by a qualified installer according to the water and electric safety regulations. Read this installation manual properly.

1.2 Check

- Before installation, check the fire for transport damage and report immediately to your supplier.
- Check whether all of the parts below are included:
 - Control box
 - Remote
 - Decoration material
 - Suction cups (2x)
 - Service door
 - Spare transducers (2x) and absorption pill

1.3 CE declaration

Product: electric fire Opti-myst

Model: e-MatriX 800/500 RD, ST

e-MatriX 800/500 RD, ST LL (Large Logs)

The product complies with the European Safety Standards EN60335-2-30 and the European Standard Electromagnetic Compatibility (EMC) EN55014, EN60555-2 and EN60555-3 these cover the essential requirements of EEC Directives 2006/95/EC and 2004/108/EC.

!! This declaration is invalid if changes are made to the fire.

2 Safety instructions

- Do not use outdoors.
- Do not use in the immediate surroundings of a bath, shower or swimming pool.
- Do not use without the glass installed in place.
- The fire must be installed according this manual.

3 Installation requirements

3.1 Water supply

- Water connection ½" or ¾" placed at an accessible location.
- Water pressure on the fire between 0,5 and 8Bar. Where required, use a pressure reducing valve.

3.2 Power supply

- Electric connection -230VAC/50Hz earthed and placed at an accessible location.

4 Installation instructions

4.1 Preparing the fire

- Ensure that all packing items are removed.
- Remove the transport screw on the front see fig. 1.0.
- Remove the front glass and store it at a safe place see Chapter 5.
- Remove the fuel bed and store it at a safe place see Chapter 6.

4.2 Placing the fire

For a proper functioning of the fire, always ensure that the fire is levelled.

4.2.1 Floor standing

Place the fire at the right position and fix it on the wall see fig. 1.1a or 1.1b.

4.3 Installation and finishing

4.3.1 e-MatriX-RD (see fig. 1.0)

4.3.1.1 With cover strip "A"

Build the false chimney breast or plateau against distance holder B.

4.3.1.2 Without cover strip "A"

Remove distance holder B around. Build the false chimney breast or plateau against the appliance.

4.3.2 e-MatriX-ST (see fig. 1.2)

4.3.2.1 With cover strip "A"

Build the false chimney breast or plateau against the appliance.

4.3.2.2 Without cover strips "A"

- Remove the cover strips A. See fig. 1.2.
- Build the false chimney breast or plateau against the appliance.

4.4 Control box

!! Place the Control box at an accessible location behind the service door.

See Chapter 13.5 and 13.7.

4.4.1 Electric connection

- Use the supplied extension cable to connect the Control box to the Engine. See fig. 4.0-B.
- Lead the DC cable, inside the Engine, to the Control box and connect it. See fig. 4.0-A.
 - Max. cable length from the center of the fire to the left 1,5m and to the right 1,0m. See fig. 1.1a or 1.1b.
- Connect the supplied mains lead. See fig. 4.0-C.

If desired, a 2m extension set is available.



4.4.2 Water connection

This appliance is equipped with the following overflow protections:

- Electromechanical valve in the Control box which is sent by an overflow sensor in the water tank.
 - Absorption valve in the Engine that kicks in when the water sump has an unexpectedly overflow see fig. 5.0-K.
- Connect all parts according flow diagram see fig. 5.0.

A = mains water	F = mesh filter	1 = safety clips (11x)
B = ½ or ¾" connector	G = in-line filter	2 = in-line filter brackets (2x)
C = ¼" 1m pipe	H = control box	3 = elbows (4x)
D = ball valve	I = ¼" 1,5m pipe	
E = to be cut from ¼" 1m pipe	J = e-MatriX engine	

- Place the water filters at an accessible location in correct alignment, there's a "flow" direction marking on both filters and Control box. See fig. 4.0.

!! Carry out a performance test see Chapter 9 and check all connections for water leakage before placing the fuel bed and front glass.

4.5 Build-in structure

- The e-MatriX needs a minimum ventilation of 50cm² above and 210cm² underneath the fire.
- The construction may not rest on the fire.
- The e-MatriX needs a minimum free space of 50mm above the fire.

5 Removing glass

5.1 Front glasses e-MatriX-RD

5.1.1 Front glass (see fig. 1.1a, provide service from this side)

- Rotate the glass clamp clockwise. See fig. 2.0a and 2.0b.
- Place the suction cups and remove the glass. See fig. 2.0c.

5.1.2 Second front glass

For cleaning only it's not necessary to remove this glass.

- Place the suction cups and remove the glass. See fig. 2.2.

For replacing the front glass repeat the steps in reverse order.

5.2 Front glasses e-MatriX-ST

5.2.1 Front glass (see fig. 1.1b, provide service from this side)

- Remove the cover strip. See fig. 2.3a, b and c.
- Rotate the glass clamp clockwise. See fig. 2.3d and 2.3e.
- Place the suction cups and remove the glass. See fig. 2.3f.

5.2.2 Second front glass

For cleaning only it's not necessary to remove this glass.

- Remove the cover strip. See fig. 2.4a, b and c.
- Remove both glass springs at the top. See fig. 2.4d.
- Place the suction cups and remove the glass. See fig. 2.4e.

For replacing the front glass repeat the steps in reverse order.

5.3 Side glass e-MatriX-RD

For cleaning only it's not necessary to remove this glass.

- Place the suction cups and remove the glass. See. 2.1.

For replacing the front glass repeat the steps in reverse order.

6 Removing fuel bed

*!! Never lift up the fuel bed without using the supplied handles.
!! Keep these handles for future use.*

6.1 e-MatriX 800/500 RD, ST:

- Remove the front glass see Chapter 5.1.1 or 5.2.1.
- Cover/remove the frame to avoid scratches see fig. 3.0b.
- Turn the handles in the fuel bed see fig. 3.0a.
- Lift up the fuel bed carefully, disconnect the plug and store it at a safe place see fig. 3.0b.

6.2 e-MatriX 800/500 RD, ST LL (Large Logs):

- Remove the front glass see Chapter 5.1.1 or 5.2.1.
- Cover/remove the frame to avoid scratches see fig. 3.1c.
- First, remove the two small logs see fig. 3.1b., before turning the handles in the fuel bed see fig. 3.1a
- Lift up the fuel bed carefully, disconnect the plug and store it at a safe place see fig. 3.1c.

For replacing the fuel bed repeat the steps in reverse order!

7 Placing decoration material

!! Keep decoration material away from children, persons with reduced physical or mental capabilities and animals.

!! Don't place decoration material in the center area see fig. 6.0 or 6.1..

The supplied artificial ash and chips can be used to personalize your fire!

8 Using the fire

8.1 Manual control - behind access door (see fig. 4.1)



- A = main switch
- 1 = ON/OFF
- 2 = pairing
- 3 = only for maintenance (service engineer)
- 4 = reduce flame
- 5 = increase flame
- 6 = reduce fire crackling sound
- 7 = increase fire crackling sound

8.2 Remote control (see fig. 4.2)

- 1 = OFF
- 2 = press once for ON/press twice for glow effect only
- 3 = reduce flame
- 4 = increase flame
- 5 = reduce fire crackling sound
- 6 = increase fire crackling sound

8.2.1 Pairing the Bluetooth remote



At the Control box see fig. 4.1:

- Turn the main switch in the ON position, 1 beep.
- Press the  button, 1 beep and the fire will begin to start.
- Press the  button, the fire starts to beep and the LED's will start to blink on and off.
- Press a button on the remote control. The fire will switch off. Now the remote control is paired to the fire.

8.3 First time water fill

- Ensure that all ball valves are open and turn on the water supply.
- Switch the fire on by pressing the mains switch to the ON position and pressing the  button see Chapter 8.1 and 8.2.
 - If the water level is high enough the flames will automatically start after 45 seconds.
 - If the water level isn't high enough the LED's continuously to blink twice after 45 seconds. Press the mains switch to the OFF position, wait 5 seconds and repeat the second step above (this process can be needed several times).

8.4 Getting the desired flame effect

- The fire always starts with minimum flame setting. When desired press the  button for higher flames. Please give the flame generator time to react to the changes you make.
!! Increasing the flame height can lead to condensation on the glass.
- Press the  and  button for the volume of the crackling sound to your desired level. The minimum volume of this sound is off.

If the fire is either turned to standby or switched off entirely, it will always revert to the minimum flame setting. The sound level will remain the same as the last sound level as set by the user.

9 Performance test

- First time water fill, see Chapter 8.3.
- Check all connections for water leakage.
- Check if the fan, mounted at the top inside the fire, is running.
- Check if the remote control is functioning at the desired distance (max. 8m)
 - If needed, move the receiver to a different position in- or outside the construction (see fig. 4.3).

The receiver is placed at the back inside the Engine and has a cable length of 1,4m.
- Replace fuel bed see Chapter 6.
- Replace front glass see Chapter 5.1.1 or 5.2..1.
- Perform a final functional check.

10 Maintenance

10.1 Maintenance frequency

- **Cleaning water sump, air filter and replacing transducers.**
Commercial use: every three months.
Domestic use: once a year.
- **Cleaning mesh filter and replacing in-line filter.**
Commercial use: once a year.
Domestic use: every second year.

!! The maintenance interval depends on the water quality and/or the running hours and therefore can differ from the above mentioned.

10.1.1 Cleaning water sump

!! Always press the mains switch to the OFF position and disconnect the power supply see fig. 4.1.

!! Never use abrasive cleaners.

- Remove the front glass see Chapter 5.1.1 or 5.2.1.
- Remove the fuel bed see Chapter 6.
- Disconnect the 'fill cap' by turning it clockwise see fig. 5.0-L and 7.0.
- Disconnect the 2 connectors, located on the right side of the water sump see fig. 7.1.
- Release the 2 clips on both sides and remove the nozzle see fig. 7.2 and 7.3.
- Gently lift up the water sump without spilling any water see fig. 7.4.
- Remove the transducers and empty the water sump.
- Put a small amount of washing up liquid into the sump, and using a soft brush to clean the sump. Also clean the transducers, including the discs underneath the cone. Remove the cone by turning it clockwise.
- When cleaned, thoroughly rinse the water sump with clean water to remove all traces of washing up liquid.
- Clean the nozzle with the a soft brush and flush out thoroughly with water.
- Reverse the steps above to reassemble.



10.1.2 Cleaning air filter

- Gently slide the air filter upwards out of its plastic holder see fig. 8.0.
- Gently rinse with water in the sink and dry with fabric towel before returning.
- Replace the filter making sure that the coarse black filter is facing the front of the fire.
- Place the fuel bed see Chapter 6.
- Place the front glass see Chapter 5.1.1 or 5.2.1.

10.1.3 Replacing transducers

!! Always press the mains switch of the Control box to the OFF position (see fig. 4.0) and disconnect the power supply.

The transducers are fixed in the water sump with plastic clips.

- Follow the first 5 steps in Chapter 10.1.1 to gain access to the transducers.
- Press the clip back and lift the transducer upwards out of its holder.
- Place the new transducers and repeat the steps above in reverse order.

10.1.4 Cleaning mesh filter

- Turn off the water supply.
- Close the ball valves.
- Unscrew the base and clean the filter inside.

10.1.5 Replacing in-line filter

- Turn off the water supply.
- Close the ball valves.
- Replace the in-line filter.
(Place it in correct alignment, there's a "flow" direction marking on the filter).

10.2 Resetting absorption valve (see fig. 5.0-K)

The absorption valve is located on the right front side at the bottom of the Engine.

- Take out the activated absorption pill.
- Fix the cause of the water leakage and remove any water at the bottom of the Engine.
- Place the new pill and open the absorption valve by pressing down the white clamp.

11 Technical data

Watts	W	250
Volts	V	230-240
Batteries remote	V	(2x) 1,5 AA
Water consumption	l/h	0,15
Inlet water pressure	Bar	0,5-8
Water connection	Inch	½ or ¾

12 Trouble shooting

Symptom	Cause	Action
The flame effect will not start.	Mains plug is not plugged in. Low water level. The transducers) are not connected properly.	Check plug is connected to wall socket correctly. See Chapter 8.3. Check that the connector(s) is inserted correctly see fig. 7.1.
e-Matrix will not start or stopped working and the LED's continuously to blink twice.	Low water level. The absorption valve is activated	See Chapter 8.3. Switch the mains switch of the Control box to the OFF position. Check all connections on water leakage. Check that the ball valves are open. See Chapter 10.2.
e-Matrix will not operate, the LED's continuously to blink once every eight seconds.	Water level too high.	Check the electromechanical valve in the Control box.
e-Matrix will not operate, the LED's continuously to blink four times.	Water filling time is too long.	Switch the mains switch of the Control box to the OFF position and heck all connections on water leakage. Close the ball valves and check the mesh filter (see fig. 5.0-F), by unscrewing the base of it to see that it is not clogged with dirt and debris.
The flame effect is too low on the highest setting.	The transducers and/or air filter are dirty.	Call for maintenance.
The flame effect is too high and there is too much smoke.	The extract fan doesn't work anymore.	Check if the fan, mounted at the top inside the fire, is running.
Remote is not working.	Low batteries. Remote isn't paired to receiver. Distance to fire too big	Place new batteries. See Chapter 8.2.1. See Chapter 9 (remote control).

13 Dimensional Drawings

13.1 e-Matrix 800/500-RD (LL)

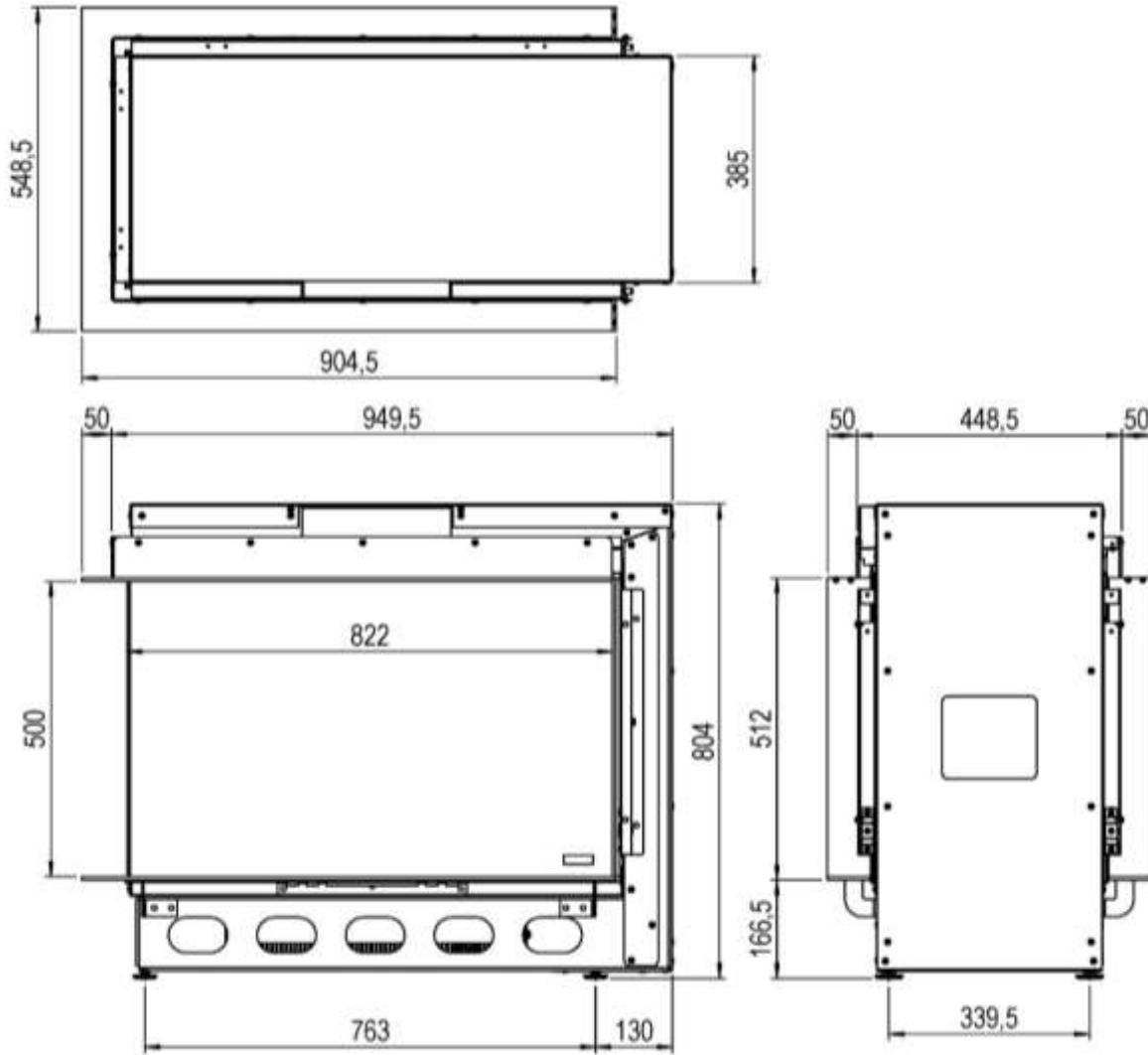

13.2 e-Matrix 800/500-ST (LL)

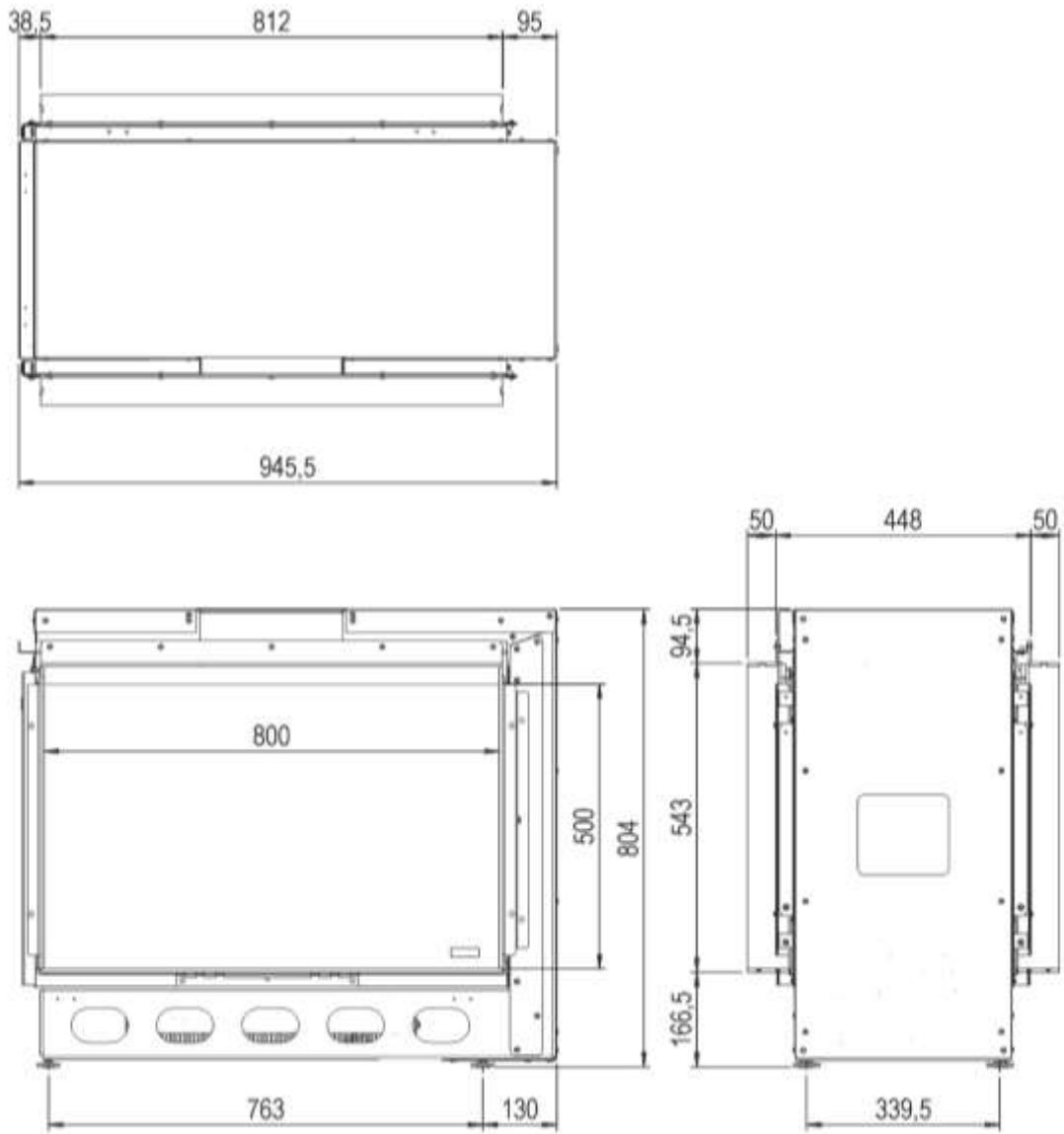

13.3 Control box

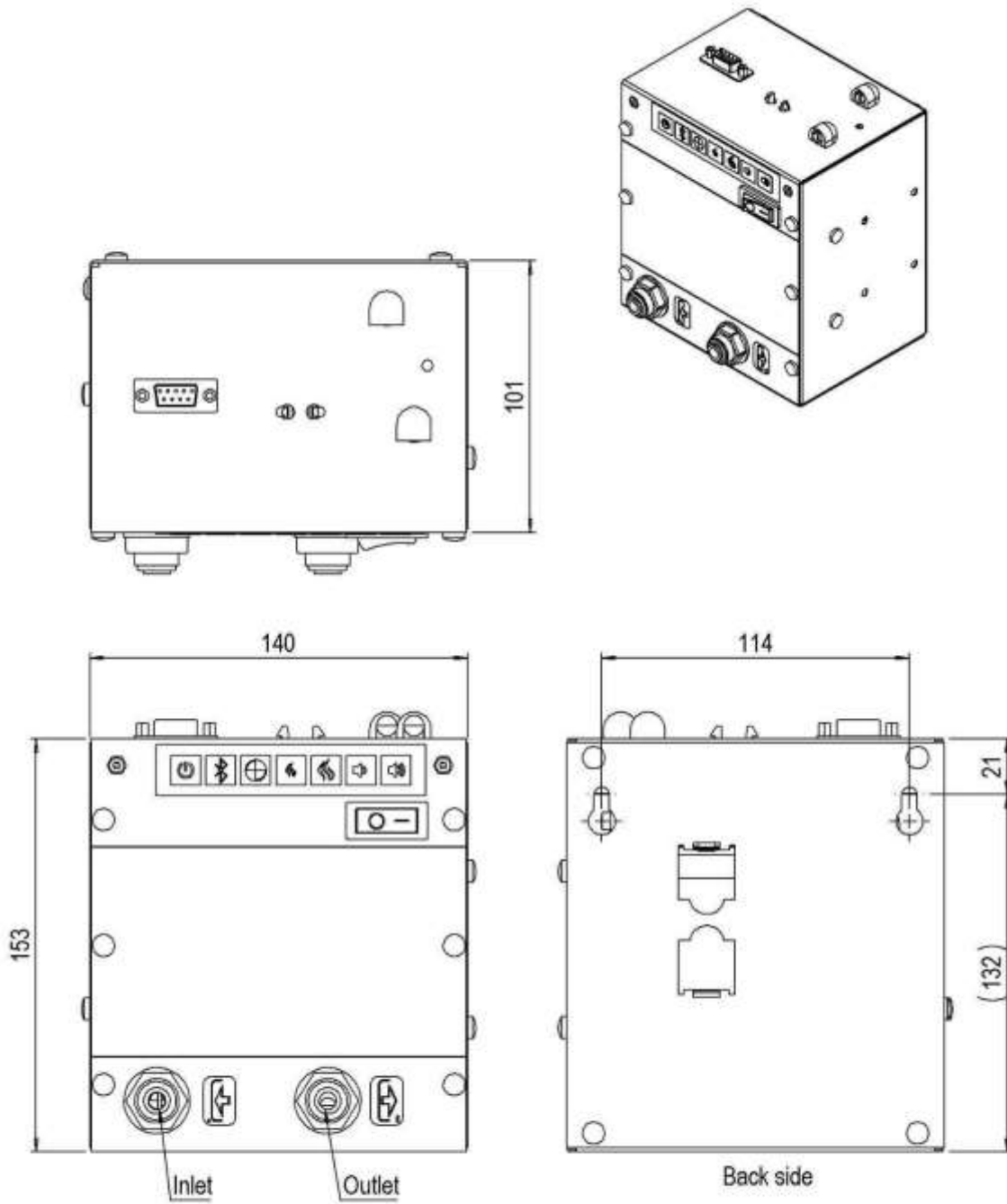

13.4 Remote access door

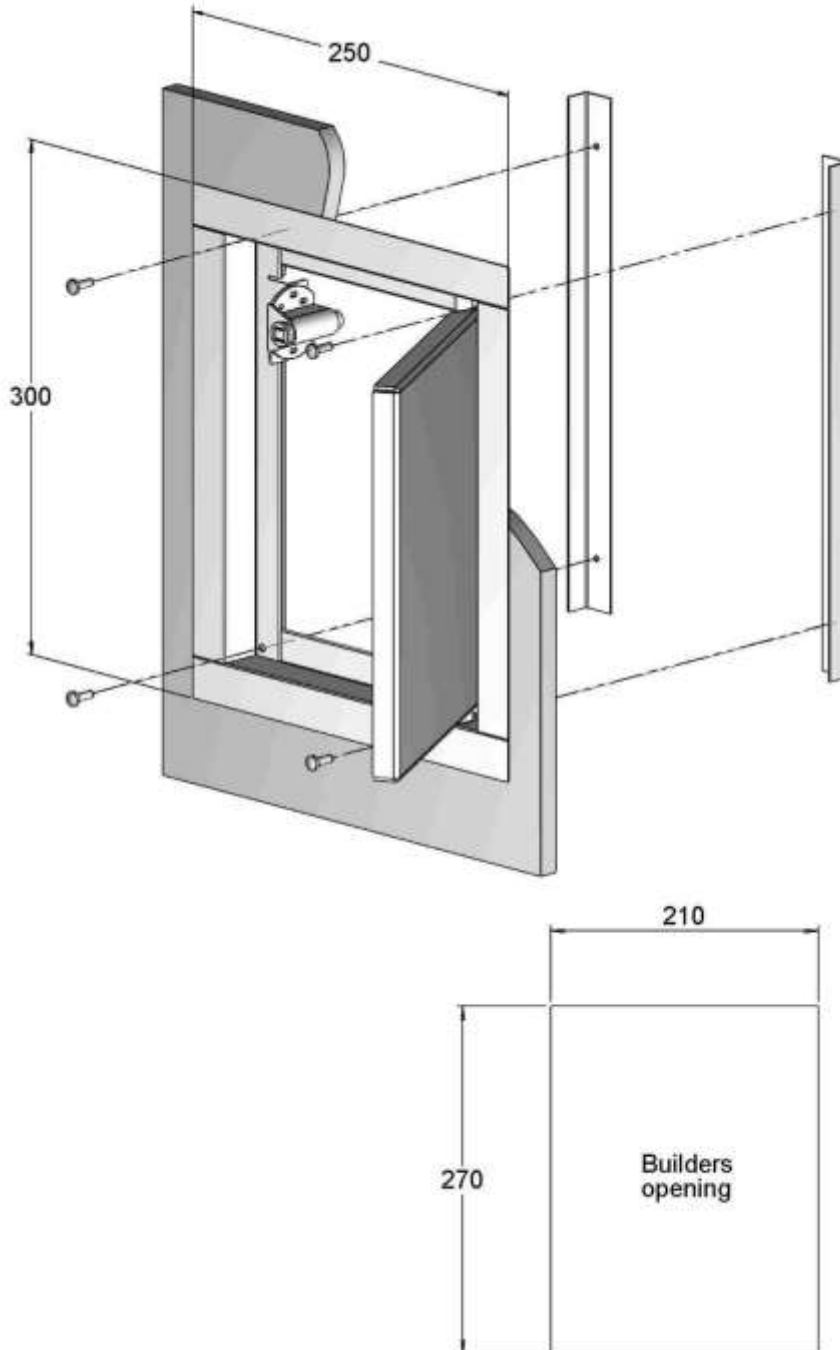





www.faber-fires.eu → - → info@faber-fires.eu¶

Saturnus-8 → → ...NL--8448-CC-Heerenveen¶

Postbus-219 → → ...NL--8440-AE-Heerenveen¶